

Data Sheet



Article number: 03441120

Description: Fluro Rod end GE 120EC-2RS

Measures

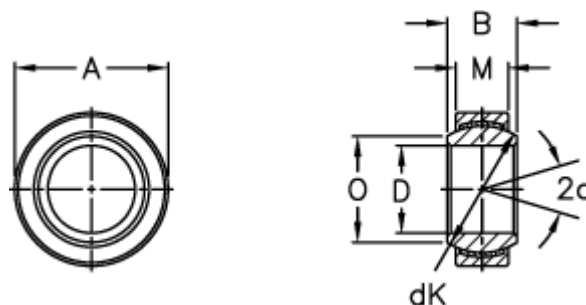

A = 180 0 -0,025

B = 85

D = 120 0 -0,020

dK = 160

Dynamic load C (kN) = 1790

M = 70

O = 135.5

Static load C0 (kN) = 3580

Tilt angle = 6

Weight = 8000